

4315 Old William Penn Highway, Monroeville, Pennsylvania 15146

p 412.856.8368 f 412.856.8969 partysavvy.com



flawless event rentals™

All Purpose Party Canopy

Assembly Instructions

20' Wide Systems

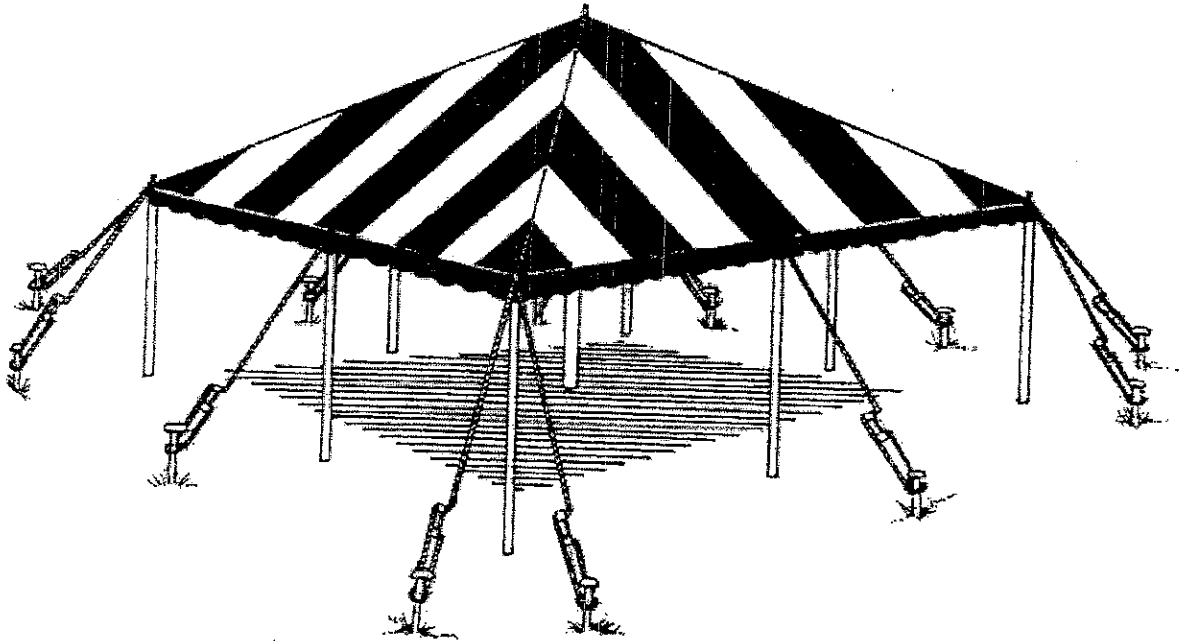

ALL-PURPOSE CANOPY PARTS LIST.

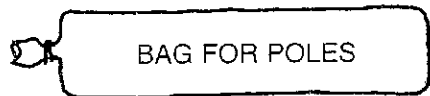
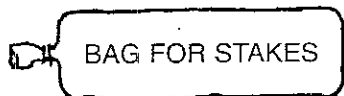
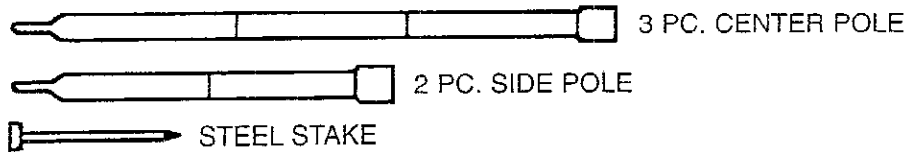

MANPOWER REQUIRED

Two installers should be able to assemble an All-Purpose Canopy in approximately thirty minutes.

TOOLS REQUIRED

Sledge Hammer

INSPECT SITE CAUTION:

Consult local utility company prior to installation.

Prior to assembly be sure to look around area for obstacles, pipes, wires, etc.

LAYOUT & CHECK

Use parts list for a quick identification and check list for proper quantities.

PARTS	CANOPY SIZE			
	10 x 10	12 x 12 THROUGH 20 x 20	20 x 30	20 x 40
SIDE POLE	4	8	10	12
CENTER POLE	1	1	2	3
STAKES	8	12	14	16
BAG WITH TOP	1	1	1	1
BAG FOR POLES	1	1	1	1
BAG FOR STAKES	1	1	1	1

1 LAYOUT AT SITE

20' X 20' canopy used as example. Spread drop cloths and unroll canopy at exact position of desired finished assembly. Any sharp objects which must remain on site under the canopy should be padded and taped. Assemble side poles and lay straight out from each pole hole in canopy. Drive a stake 1'-0" from the end of each pole. The stake must be driven through the ring attached to each guy rope as shown.

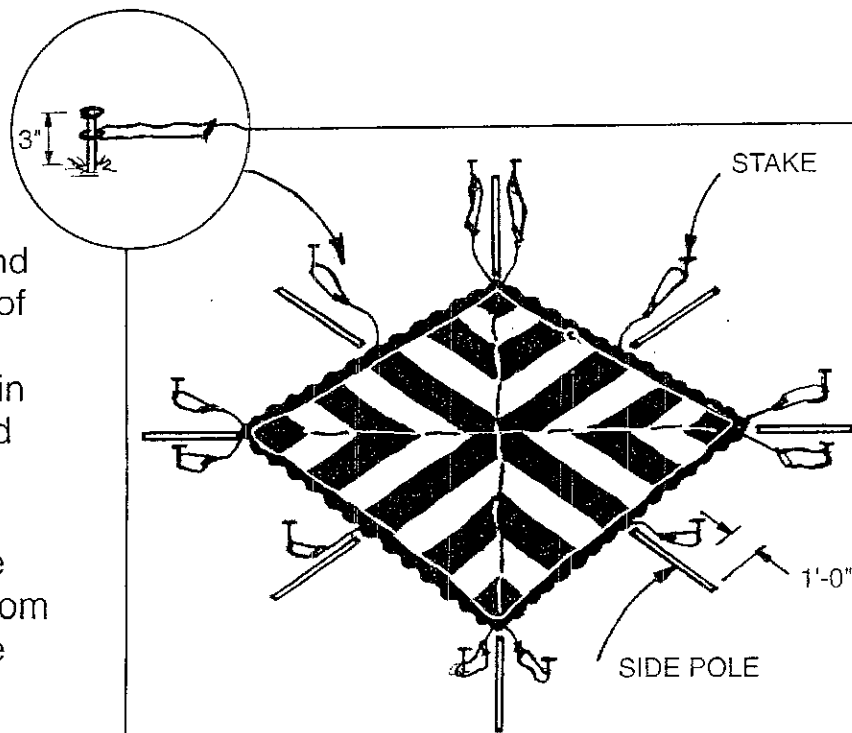

2

RAISE SIDE POLES

Start at opposite corners.

Insert side poles into pole holes and raise so that bottom of poles slant toward center of canopy.

Adjust guy rope.

Continue with other two corners and then sides.

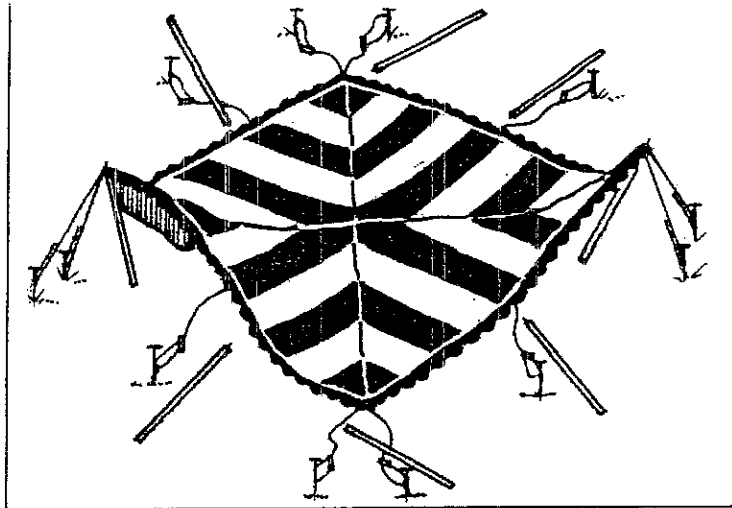

3

RAISE CENTER POLE

Assemble three piece center pole and insert into center pole hole.

Raise to upright position and tie off jump rope to pole.

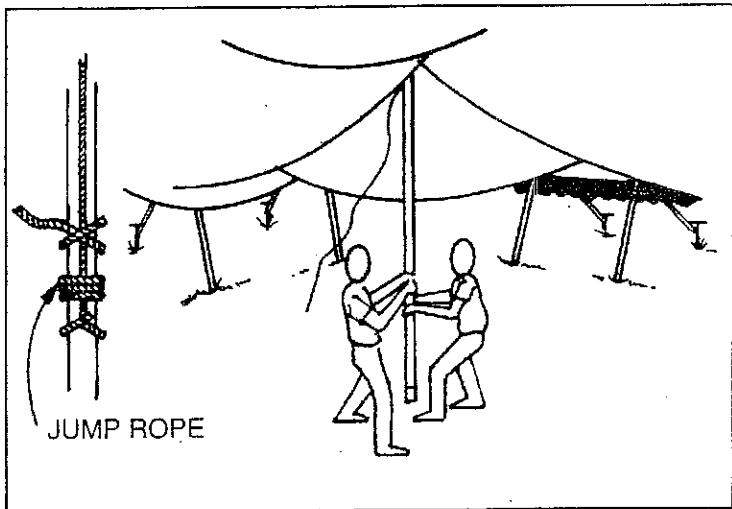

4

SIDE POLE ADJUSTMENT

Tighten guy ropes and then set side poles to upright position. Adjust pole positions and guy rope tension to properly pull out canopy.

Protective covers are recommended for all stakes.

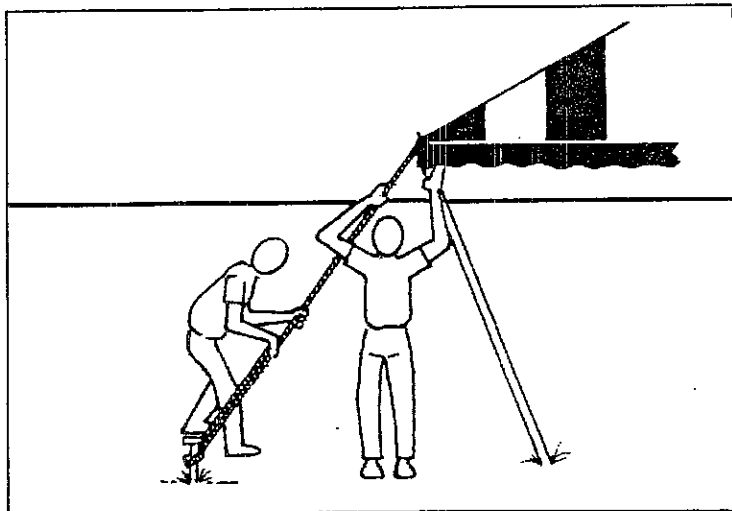

5

TAKE DOWN

Loosen all guy ropes.

Spread drop cloths.

Reverse steps 1 through 4 for disassembly.

IMPORTANT:

Check Guys Ropes periodically for tightness and maintaining of good condition. Stakes provided are for average soil conditions. Sandy soil or asphalt may require additional staking. Proper installation suitable to site conditions is the responsibility of the installer. Store canopy in a cool, dry area. Never store while wet or damp.

CAUTION:

1. For each installation, the installer is solely responsible for evaluating the site and the proper securing method determined. Some soils require different staking or securing than that provided with the tent. Due to this variety of soil conditions, these are the manufacturer's suggested sequence of installation procedures. Anchor's responsibility is limited to the manufacture of the tent parts and materials. We are not responsible for methods that installers may choose to erect and secure the tent to the ground.
2. The number of stakes suggested in the installation instructions does not necessarily meet all or any relevant codes on the site of the tent installation. The number of stakes suggested **will, in many cases, keep the tent erected**, however, due to various soil conditions; these stakes will be insufficient to **keep the tent secure in high winds**. It is the tent installer's responsibility, not the manufacturer, to determine the appropriate number of stakes to meet the necessary wind loads on the site. Regardless of the number of stakes we suggest, we make no representation or warranty as to whether this specific number of stakes will meet the local tent code. Anchor does not, nor can it make any suggestions, representation, or warranties about the adequate staking required at each specific installation site. Staking information provided in the installation instructions **is not a suggestion about what is necessary to meet a site-specific load**.

For additional assistance, consult: "The IFAI Procedural Handbook For the Safe Installation and Maintenance of Tentage" and the IFAI Pocket Guide "Pullout Capacity of Tent Stakes", both available from the IFAI Tent Rental Division or on our website.

3. Inasmuch as the weather is unpredictable, good judgment and common sense must be incorporated within installation guidelines. It is the responsibility of the tent installer/maintainer to determine the severity of the weather, proper time and method of installation and/or erection and disassembly. **Note: We recommend that snow and ice be removed from the tent surface as soon as possible because accumulation will damage the tent or fabric structure. Please consult with our Engineering Department about the maximum loads for each product.**

This product has been manufactured for use as a temporary sunshade structure. For the safety of all occupants, evacuation is recommended if threatening weather occurs, or if there is any doubt concerning the safe use of this product.

4. Proper safety equipment should be used at all times to insure a safe installation and take down. We suggest a careful evaluation be made to determine safety equipment needed, such as hard hats, steel-toe shoes, safety glasses and other as required. It is our desire that all installations are safe. Please be aware of hidden dangers both underground, i.e., gas lines, water lines, electrical lines, etc. and above the tent such as power lines and telephone lines.
5. Anchor stands behind its products in accordance with its standard Terms and Conditions of sale. A copy of our Terms and Conditions of Sale can be obtained by contacting Anchor at the telephone number and/or address on this document.